

Digital electronic E-BM-AES drivers

DIN-rail format, for proportional valves without transducer

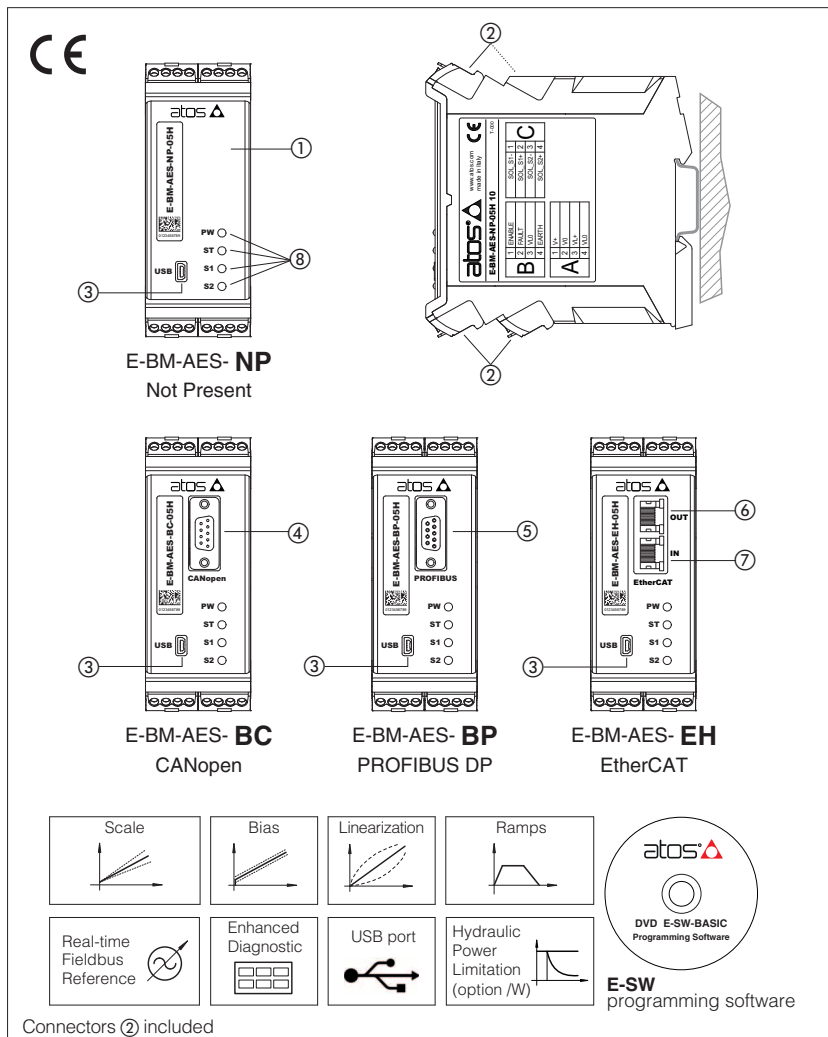

E-BM-AES

Digital drivers ① control the current to the solenoid of Atos proportional valves without transducer, according to the electronic reference input signal.

E-BM-AES operate direct and pilot operated proportional valves ZO-A without transducer.

Atos PC software allows to customize the driver configuration to the specific application requirements.

Electrical Features:

- 7 fast plug-in connectors ②
- Mini USB port ③ always present
- DB9 CANopen ④ and PROFIBUS DP ⑤ communication connector
- RJ45 EtherCAT communication connectors ⑥ output and ⑦ input
- 4 leds for diagnostics ⑧ (see 4.1)
- ± 5 Vdc output supply for external reference potentiometer
- Electrical protection against reverse polarity of power supply
- Operating temperature range: $-20 \div +60$ °C
- Plastic box with IP20 protection degree and standard DIN-rail mounting
- CE mark according to EMC directive

Software Features:

- Intuitive graphic interface
- Setting of valve's functional parameters: bias, scale, ramps, dither, PID gains
- Linearization function for hydraulic regulation
- /W option max power limitation function
- Complete diagnostics of driver status
- Internal oscilloscope function
- In field firmware update through USB port

Fieldbus Features:

- Valve direct communication with machine control unit for digital reference, diagnostics and settings
- Fieldbus execution allow to operate the valves via fieldbus or via analog signals available on the connectors (see 4.2)

1 MODEL CODE

E-BM	-	AES	-	NP	-	01H	/	*	*
Off-board electronic driver in DIN rail format								Series number	
AES = digital full driver, for valves without transducer								Options: A = max current limitation for Ex-proof valves C = current feedback $4 \div 20$ mA for remote transducer, only in combination with option W I = current reference input $4 \div 20$ mA (omit for standard voltage reference input ± 10 Vdc) W = power limitation function	
Fieldbus interface - USB port always present: NP = Not Present BC = CANopen BP = PROFIBUS DP EH = EtherCAT								01H = for single solenoid proportional valves 05H = for double solenoid proportional valves	

2 VALVES RANGE

Valves	Pressure									Directional			Cartridge	Flow
Industrial	RZMO	RZME	RZGO	RZGE	AGMZO	AGMZE	AGRCZO	DHRZO	DHRZE	DHZO	DHZE	DPZO	LI*ZO	QVHZO
Tech table	HMZO	F005	HZGO, KZGO	CART RZGE	FS035	F030	FS050	FS025	F022	DKZOR	DKZE	FS170	FS300	QVKZOR
Ex-proof	RZMA	-	RZGA	-	AGMZA	-	AGRCZA	DHRZA	-	DHZA	-	DPZA	LI*ZA	QVHZA
Tech table	HZMA	-	HZGA, KZGA	-	FX010	-	FX040	FX070	-	DKZA	-	FX200	FX300	QVKZA
	FX010		FX040							FX100				FX400

3 MAIN CHARACTERISTICS

Power supply (see 5.1, 5.2)	Nominal : +24 Vdc Rectified and filtered : $V_{RMS} = 20 \div 32 V_{MAX}$ (ripple max 10 % V_{PP})			
Max power consumption	50 W			
Current supplied to solenoids	$I_{MAX} = 2.7$ A with +24 Vdc power supply to drive standard proportional valves (3,2 Ω solenoid) $I_{MAX} = 2.5$ A with +24 Vdc power supply to drive ex-proof proportional valves (3,2 Ω solenoid) for /A option			
Analog input signals (see 5.3)	Voltage: maximum range ± 10 Vdc Input impedance: $R_i > 50$ k Ω Current: maximum range ± 20 mA Input impedance: $R_i = 500$ Ω			
Monitor output (see 5.4)	Voltage: maximum range ± 5 Vdc @ max 5 mA			
Enable input (see 5.5)	Range : 0 \div 9 Vdc (OFF state), 15 \div 24 Vdc (ON state), 9 \div 15 Vdc (not accepted); Input impedance: $R_i > 87$ k Ω			
Output supply (see 5.8)	± 5 Vdc @ max 10 mA : output supply for external potentiometer			
Fault output (see 5.6)	Output range : 0 \div 24 Vdc (ON state \cong VL+ [logic power supply] ; OFF state \cong 0 V) @ max 50 mA; external negative voltage not allowed (e.g. due to inductive loads)			
Pressure transducer power supply (only for /W option)	+24Vdc @ max 100 mA (E-ATR-8 see tech table GS465)			
Alarms	Solenoid not connected/short circuit, cable break with current reference signal, over/under temperature, power supplies level, pressure transducer failure			
Format	Plastic box ; IP20 protection degree ; L 35 - H 7,5 mm DIN-rail mounting as per EN60715			
Operating temperature	$-20 \div +60$ $^{\circ}$ C (storage $-25 \div +85$ $^{\circ}$ C)			
Mass	Approx. 330 g			
Additional characteristics	Short circuit protection of solenoid current supply; current control by P.I.D. with rapid solenoid switching; protection against reverse polarity of power supply			
Compliance	CE according to EMC directive 2014/30/EU (Immunity: EN 61000-6-2; Emission: EN 61000-6-3) RoHS Directive 2011/65/EU as last update by 2015/65/EU REACH Regulation (EC) n $^{\circ}$ 1907/2006			
Communication interface	USB Atos ASCII coding	CANopen EN50325-4 + DS408	PROFIBUS DP EN50170-2/IEC61158	EtherCAT IEC61158
Communication physical layer	not insulated USB 2.0 + USB OTG	optical insulated CAN ISO11898	optical insulated RS485	Fast Ethernet 100 Base TX
Recommended wiring cable	LiYCY shielded cables: 0,5 mm 2 max 50 m for logic - 1,5 mm 2 max 50 m for power supply and solenoids			
Max conductor size (see 9)	2,5 mm 2			

Note: a maximum time of 500 ms (depending on communication type) have be considered between the driver energizing with the 24 Vdc power supply and when the valve is ready to operate. During this time the current to the valve coils is switched to zero.

4 CONNECTIONS AND LEDS

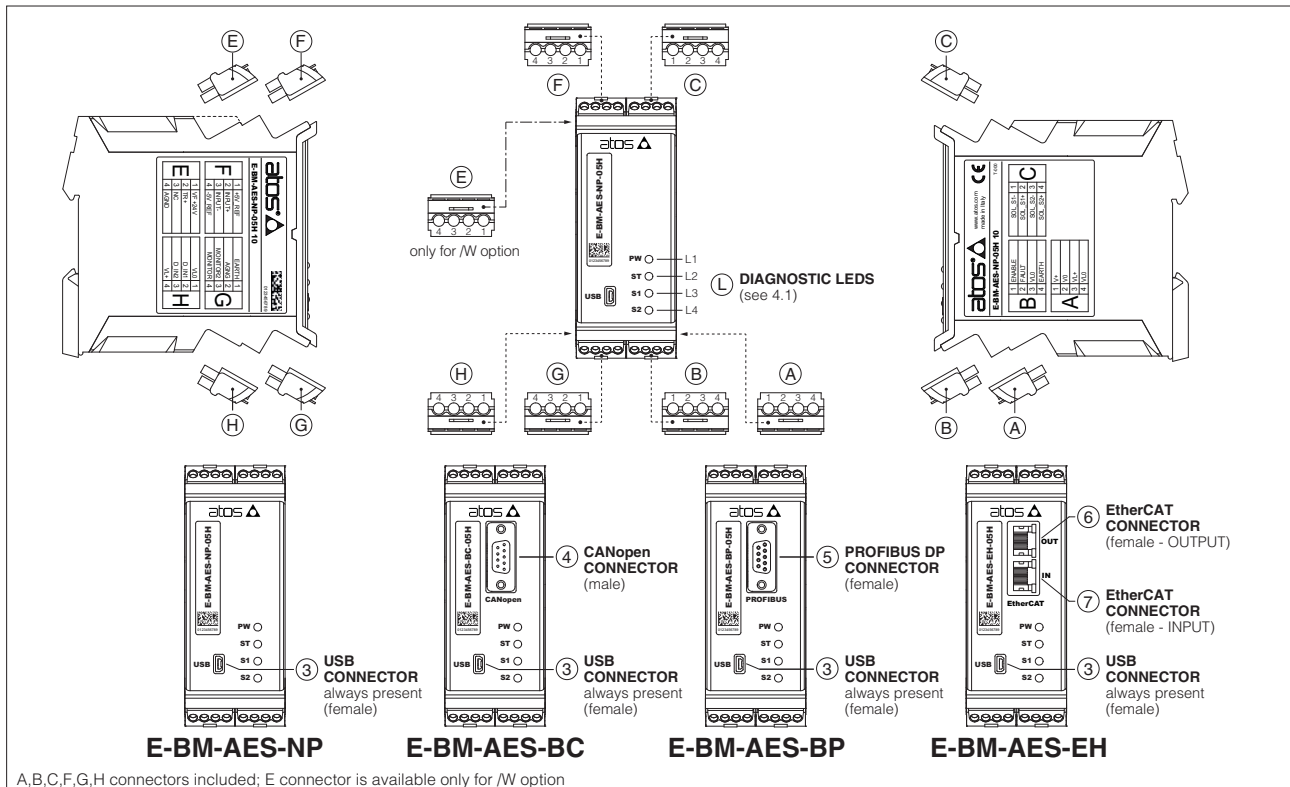

4.1 Diagnostic LEDs (L)

Four leds show driver operative conditions for immediate basic diagnostics. Please refer to the driver user manual for detailed information.

LED	COLOR	FUNCTION	FLASH RATE	DESCRIPTION
L1	GREEN	PW	OFF	Power supply OFF
			ON	Power supply ON
L2	GREEN	ST	OFF	Fault present
			ON	No fault
L3 and L4	YELLOW	S1 and S2	OFF	PWM command OFF
			ON	PWM command ON

4.2 Connectors - 4 pin

CONNECTOR	PIN	SIGNAL	TECHNICAL SPECIFICATIONS	NOTES
A	A1	V+	Power supply 24 Vdc (see 5.1)	Input - power supply
	A2	V0	Power supply 0 Vdc (see 5.1)	Gnd - power supply
	A3	VL+	Power supply 24 Vdc for driver's logic and communication (see 5.2)	Input - power supply
	A4	VLO	Power supply 0 Vdc for driver's logic and communication (see 5.2)	Gnd - power supply
B	B1	ENABLE	Enable (24 Vdc) or disable (0 Vdc) the driver, referred to VLO (see 5.5)	Input - on/off signal
	B2	FAULT	Fault (0 Vdc) or normal working (24 Vdc), referred to VLO (see 5.6)	Output - on/off signal
	B3	VLO	Ground for ENABLE and FAULT	Gnd - digital signals
	B4	EARTH	Connect to system ground	
C	C1	SOL_S1-	Negative current to solenoid S1	Output - power PWM
	C2	SOL_S1+	Positive current to solenoid S1	Output - power PWM
	C3	SOL_S2-	Negative current to solenoid S2	Output - power PWM
	C4	SOL_S2+	Positive current to solenoid S2	Output - power PWM
E available only for /W option	E1	VF +24V	Power supply +24 Vdc	Output - power supply
	E2	TR+	Positive pressure transducer input signal: ± 10 Vdc / ± 20 mA maximum range (see 5.7) Default are 0 ÷ 10 Vdc for standard and 4 ÷ 20 mA for /C option	Input - analog signal Software selectable
	E3	NC	Do not connect	
	E4	AGND	Common GND for transducer power, signals and external potentiometer	
F	F1	+5V_REF	External potentiometer power supply +5 Vdc @ 10mA (see 5.8)	Output - power supply
	F2	INPUT+	Positive reference input signal: ± 10 Vdc / ± 20 mA maximum range (see 5.3) Default are ± 10 Vdc for standard and 4 ÷ 20 mA for /I option	Input - analog signal Software selectable
	F3	INPUT-	Negative reference input signal for INPUT+	Input - analog signal
	F4	-5V_REF	External potentiometer power supply -5 Vdc @ 10mA (see 5.8)	Output - power supply
G	G1	EARTH	Connect to system ground	
	G2	AGND	Analog ground for MONITOR and external potentiometer	Gnd - analog signal
	G3	MONITOR2	Only for /W option, 2nd monitor output signal: ± 5 Vdc maximum range (see 5.4) Default is 0 ÷ 5 Vdc	Output - analog signal Software selectable
	G4	MONITOR	Monitor output signal: ± 5 Vdc maximum range (see 5.4) Default is ± 5 Vdc (1V = 1A)	Output - analog signal Software selectable
H	H1	VLO	Power supply 0 Vdc for digital input (see 5.2)	Gnd - power supply
	H2	D_IN1	Digital input 0 ÷ 24Vdc, referred to VLO	Input - on/off signal
	H3	D_IN0	Digital input 0 ÷ 24Vdc, referred to VLO	Input - on/off signal
	H4	VL+	Power supply 24 Vdc for digital input (see 5.2)	Output - power supply

Pressure transducer connections - only for /W option

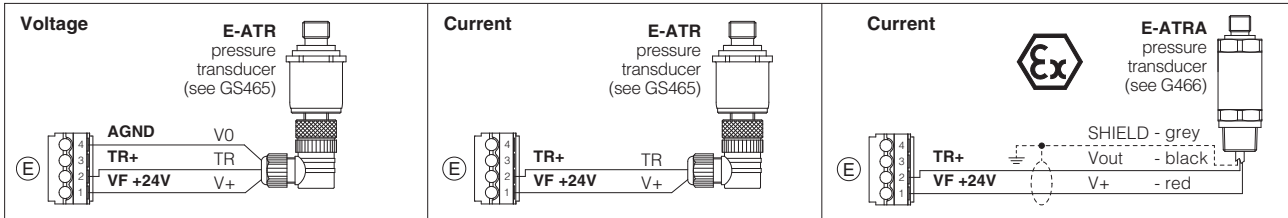

Coils connection

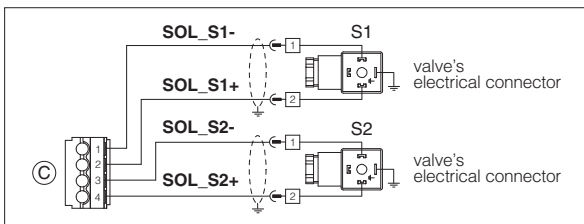

Potentiometer connection

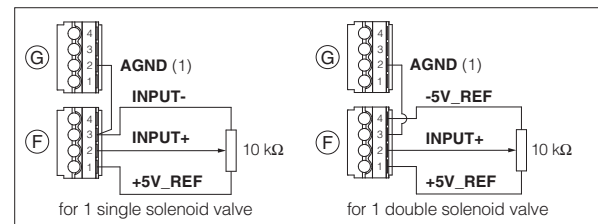

4.3 Communication connectors ③ - ④ - ⑤ - ⑥ - ⑦

③ USB connector - Mini USB type B always present		
PIN	SIGNAL	TECHNICAL SPECIFICATION (1)
1	+5V_USB	Power supply
2	D-	Data line -
3	D+	Data line +
4	ID	Identification
5	GND_USB	Signal zero data line

⑤ BP fieldbus execution, connector - DB9 - 9 pin		
PIN	SIGNAL	TECHNICAL SPECIFICATION (1)
1	SHIELD	
3	LINE-B	Bus line (low)
5	DGND	Data line and termination signal zero
6	+5V	Termination supply signal
8	LINE-A	Bus line (high)

④ BC fieldbus execution, connector - DB9 - 9 pin		
PIN	SIGNAL	TECHNICAL SPECIFICATION (1)
2	CAN_L	Bus line (low)
3	CAN_GND	Signal zero data line
5	CAN_SHLD	Shield
7	CAN_H	Bus line (high)

⑥ ⑦ EH fieldbus execution, connector - RJ45 - 8 pin		
PIN	SIGNAL	TECHNICAL SPECIFICATION (1)
1	TX+	Transmitter - white/orange
2	RX+	Receiver - white/green
3	TX-	Transmitter - orange
6	RX-	Receiver - green

(1) shield connection on connector's housing is recommended

5 POWER SUPPLY AND SIGNALS SPECIFICATIONS

Atos digital drivers are CE marked according to the applicable directives (e.g. Immunity and Emission EMC Directive). Installation, wirings and start-up procedures must be performed according to the general prescriptions shown in tech table **FS900** and in the user manuals included in the E-SW-* programming software.

Generic electrical output signals of the valve (e.g. fault or monitor signals) must not be directly used to activate safety functions, like to switch-ON/OFF the machine's safety components, as prescribed by the European standards (Safety requirements of fluid technology systems and components-hydraulics, ISO 4413).

5.1 Power supply (V+ and V0)

The power supply must be appropriately stabilized or rectified and filtered: apply at least a 10000 μ F/40 V capacitance to single phase rectifiers or a 4700 μ F/40 V capacitance to three phase rectifiers.
In case of double power supply see 5.2.

⚠ A safety fuse is required in series to each power supply: 2,5 A time lag fuse.

5.2 Power supply for driver's logic and communication (VL+ and VL0)

The power supply for driver's logic and communication must be appropriately stabilized or rectified and filtered: apply at least a 10000 μ F/40 V capacitance to single phase rectifiers or a 4700 μ F/40 V capacitance to three phase rectifiers.
The separate power supply for driver's logic on pin A3 and A4, allow to remove solenoid power supply from pin A1 and A2 maintaining active the diagnostics, USB and fieldbus communications.

⚠ A safety fuse is required in series to each driver's logic and communication power supply: 500 mA fast fuse.

5.3 Reference input signal (INPUT+)

The driver controls in closed loop the current to the valve proportionally to the external reference input signal.
Reference input signal is factory preset according to selected valve code, defaults are ± 10 V_{dc} for standard and $4 \div 20$ mA for /I option.
Input signal can be reconfigured via software selecting between voltage and current, within a maximum range of ± 10 V_{dc} or ± 20 mA.
Drivers with fieldbus interface (BC, BP, EH) can be software set to receive reference signal directly from the machine control unit (fieldbus reference). Analog reference input signal can be used as on-off commands with input range $0 \div 24$ V_{dc}.

5.4 Monitor output signals (MONITOR and MONITOR2)

The driver generates an analog output signal (MONITOR) proportional to the actual coil current of the valve; the monitor output signal can be software set to show other signals available in the driver (e.g. analog reference, fieldbus reference).
Monitor output signal is factory preset according to selected valve code, default settings is ± 5 V_{dc} (1V = 1A).
Output signal can be reconfigured via software, within a maximum range of ± 5 V_{dc}.

Option /W

The driver generates a second analog output signal (MONITOR2) proportional to the actual system pressure.
The output maximum range is ± 5 V_{dc}; default setting is $0 \div 5$ V_{dc}.

5.5 Enable input signal (ENABLE)

To enable the driver, supply 24 V_{dc} on pin B1: Enable input signal allows to enable/disable the current supply to the solenoid, without removing the electrical power supply to the driver; it is used to active the communication and the other driver functions when the valve must be disabled for safety reasons. This condition does not comply with European Norms EN13849-1 (ex EN954-1).

5.6 Fault output signal (FAULT)

Fault output signal indicates fault conditions of the driver (solenoid short circuits/not connected, reference signal broken for $4 \div 20$ mA input, etc.).
Fault presence corresponds to 0 V_{dc}, normal working corresponds to 24 V_{dc}.
Fault status is not affected by the Enable input signal.

5.7 Remote pressure transducer input signal (TR+) - only for /W option

Analog pressure transducers can be directly connected to the driver.
Analog input signal is factory preset according to selected driver code, defaults are $0 \div 10$ V_{dc} for standard and $4 \div 20$ mA for /C option.
Input signal can be reconfigured via software selecting between voltage and current, within a maximum range of ± 10 V_{dc} or ± 20 mA.
Note: transducer feedback can be read as a digital information through fieldbus communication - software selectable.

5.8 Output supply for external potentiometer (± 5 V_REF) - not available for EH version

The reference analog signal can be generated by one external potentiometer directly connected to the driver, using the ± 5 V_{dc} supply output available at pin F1 and F4.
Note: using an external potentiometer, the reference input signal must be set via software at ± 5 V_{dc} (default ± 10 V_{dc}, see 5.3)

5.9 Possible combined options: /AI, /AW, /IW, /AIW, /ACW, /CIW, /ACIW, /CW

6 VALVE SETTINGS AND PROGRAMMING TOOLS

Valve's functional parameters and configurations, can be easily set and optimized using Atos E-SW programming software connected via USB port to the digital driver (see table **FS900**).
For fieldbus versions, the software permits valve's parameterization through USB port also if the driver is connected to the central machine unit via fieldbus.

The software is available in different versions according to the driver's options (see table **GS500**):

E-SW-BASIC	support: NP (USB)	PS (Serial)	IR (Infrared)
E-SW-FIELDBUS	support: BC (CANopen)	BP (PROFIBUS DP)	EH (EtherCAT)
		EW (POWERLINK)	EI (EtherNet/IP)
			EP (PROFINET)
E-SW-*/PQ	support: valves with SP, SF, SL alternated control (e.g. E-SW-BASIC/PQ)		

⚠ **WARNING: drivers USB port is not isolated!** For E-C-SB-USB/BM cable, the use of isolator adapter is highly recommended for PC protection

Free programming software, web download:

E-SW-BASIC web download = software can be downloaded upon web registration at www.atos.com; service and DVD not included
Upon web registration user receive via email the Activation Code (software free license) and login data to access Atos Download Area

DVD programming software, to be ordered separately:

E-SW-*/PQ DVD first supply = software has to be activated via web registration at www.atos.com; 1 year service included
Upon web registration user receive via email the Activation Code (software license) and login data to access Atos Download Area

E-SW-*/N/PQ DVD next supplies = only for supplies after the first; service not included, web registration not allowed
Software has to be activated with Activation Code received upon first supply web registration

Atos Download Area: direct access to latest releases of E-SW software, manuals, USB drivers and fieldbus configuration files at www.atos.com

USB Adapters, Cables and Terminators, can be ordered separately

USB connection

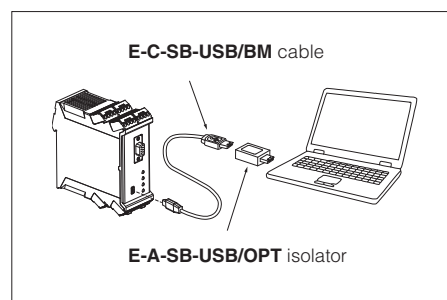

7 MAIN SOFTWARE PARAMETER SETTINGS

The following is a brief description of the main settings and features of digital drivers. For a detailed descriptions of available settings, wirings and installation procedures, please refer to the user manual included in the E-SW programming software:

E-MAN-BM-AES - user manual for **E-BM-AES**

7.1 Scale

Scale function allows to set the maximum current supplied to the solenoid, corresponding to the max valve regulation, at maximum reference signal value.

This regulation allows to adapt the maximum current supplied from the driver to the specific nominal current of the proportional valves to which the driver is coupled; it is also useful to reduce the maximum valve regulation in front of maximum reference signal.

Two different Scale regulations are available for double solenoid valves: ScaleA for positive reference signal and ScaleB for negative reference signal.

7.1, 7.2 - Scale, Bias & Threshold

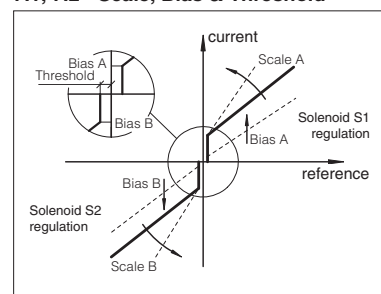

7.2 Bias and Threshold

Proportional valves may be provided with a dead band in the hydraulic regulation corresponding to their switch-off status.

This dead band discontinuity in the valve's regulation can be compensated by activating the Bias function, which adds a fixed preset Bias value to the reference signal (analog or fieldbus external input).

The Bias function is activated when the reference signal overcomes the Threshold value, preset into the driver.

The Bias setting allows to calibrate the Bias current to the specific proportional valve to which the driver is coupled.

The Threshold setting is useful to avoid undesired valve regulation at zero reference signal when electric noise is present on the analog input signal: smaller threshold reduces the reference signal dead band, greater values are less affected by electric noise presence.

If fieldbus reference signal is active (see 5.3), threshold should be set to zero.

Two different Bias regulations are available for double solenoid valves: positive reference signals activate BiasA and negative reference signals activate BiasB.

Refer to the programming manuals for a detailed description of other software selectable Bias functions.

7.3 - Offset

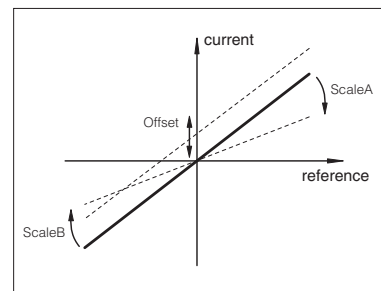

7.3 Offset

Proportional valves may be provided with zero overlapping in the hydraulic regulation corresponding to zero reference input signal (valve's central spool position).

The Offset function allows to calibrate the Offset current, required to obtain valve's spool central position, to the specific hydraulic system setup (e.g. valve applied to cylinder with differential areas).

7.4 Ramps

The ramp generator allows to convert sudden change of electronic reference signal into smooth time-dependent increasing/decreasing of the current supplied to the solenoid.

Different ramp mode can be set:

- single ramp for any reference variation
- two ramps for increasing and for decreasing reference variations
- four ramps for positive/negative signal values and increasing/decreasing reference variations

Ramp generator is useful for application where smooth hydraulic actuation is necessary to avoid machine vibration and shocks.

If the proportional valve is driven by a closed loop controller, the ramps can lead to unstable behaviour, for these applications ramp function can be software disabled (default setting).

7.4 - Ramps

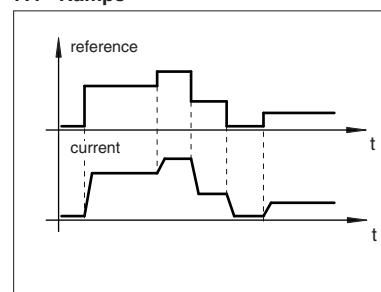

7.5 Linearization - E-SW level 2 functionality

Linearization function allows to set the relation between the reference input signal and the controlled valve's regulation.

Linearization is useful for applications where it is required to linearize the valve's regulation in a defined working condition.

7.5 - Linearization

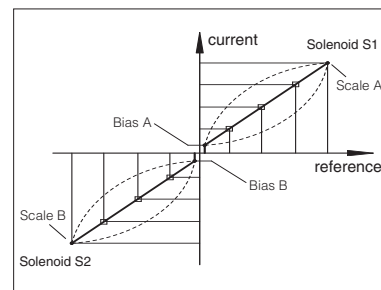

7.6 Variable Dither

The dither is the frequency modulation of the current supplied to the solenoid. To reduce the hysteresis should be selected a lower value of frequency, despite a lower regulation stability, because a small vibration in the valve regulating parts considerably reduces static friction effects.

To improve the regulation stability, should be selected a high value of frequency, despite a higher hysteresis. This solution in some application can lead to vibration and noise. Normally, the right setting is a compromise and depends on system setup.

E-BM-AES drivers allow to realize a variable dither frequency that linearly depends on the demanded current: variable dither frequency allows an higher degree to optimize the valve hysteresis.

7.6 - Variable Dither

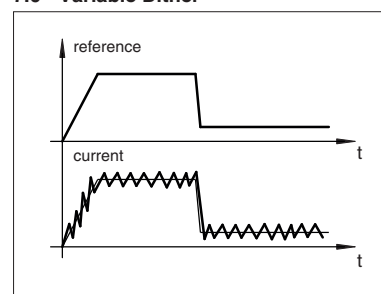

7.7 Hydraulic Power Limitation - only for /W option

Digital E-BM-AES drivers with /W option electronically perform hydraulic power limitation on:

- direct and pilot operated flow control valves
- direct and pilot operated directional control valves + mechanical pressure compensator
- variable displacement pumps with proportional flow regulator (e.g. PVPC-*-LQZ, tech table A170)

The driver receives the flow reference signal by the analog external input INPUT+ (see 5.3) and a pressure transducer, installed in the hydraulic system, has to be connected to the driver's analog input TR (see 5.7).

When the actual requested hydraulic power $p \times Q$ (TR x INPUT+) reaches the max power limit ($p_1 \times Q_1$), internally set by software, the driver automatically reduces the flow regulation of the valve. The higher is the pressure feedback the lower is the valve's regulated flow:

7.7 - Hydraulic Power Limitation

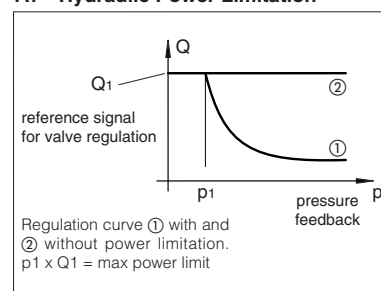

$$\text{Flow regulation} = \text{Min} \left(\frac{\text{PowerLimit [sw setting]}}{\text{Transducer Pressure [TR]}} ; \text{Flow Reference [INPUT+]} \right)$$

8 OVERALL DIMENSIONS [mm]

overall dimension with assembled connectors

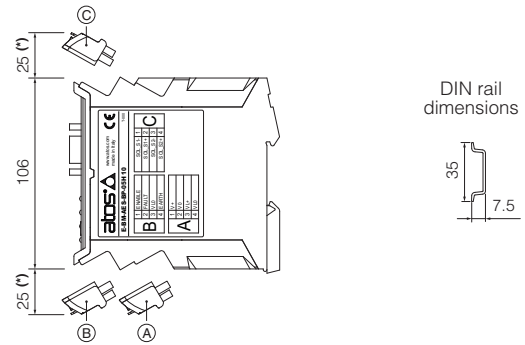
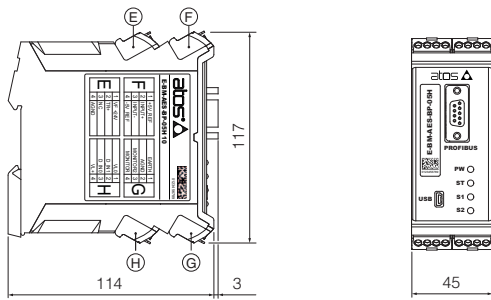

A,B,C,F,G,H connectors included; E connector is available only for *M* option

(*) Space to remove the connectors

9 INSTALLATION

To wire cables in the connectors:

1. insert cable into the termination
2. turn screw with a screwdriver

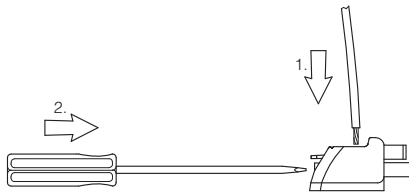

Note: max conductor size: 2,5 mm²
tightening torque: 0,4 ÷ 0,6 Nm

To unlock the driver from the DIN rail:

1. pull down the locking slide with a screwdriver
2. rotate up the driver

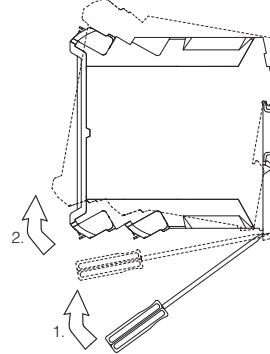

To extract the connectors:

1. push lever
2. pull connector

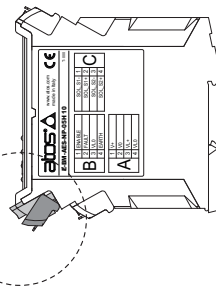
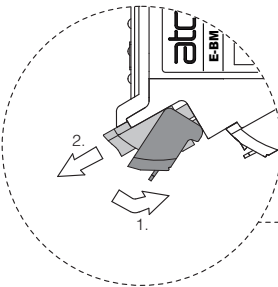

To insert the connectors:

1. push the connector in its slot

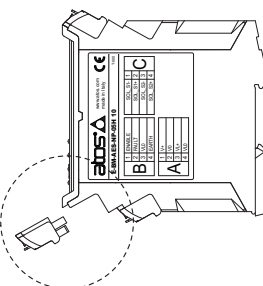
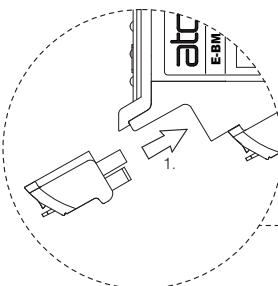

Note: all connectors are supplied with a mechanical coding. This feature ensures a unique insertion of each connector in the own slot (eg. connector A can not be inserted into connector slot of B, C, E, F, G, H)